

Table Top Rack Cabinets Heavy Duty - Ventilated (RCHV Series)



Features:









- Heavy duty, 16-gauge steel, 19" table top rack cabinet...
- Ventilated on both sides & optimized per size to allow natural air convection...
- For solid side versions link to our [RCHS series](#)...
- Panel rails are infinitely adjustable (front to back), round hole punched for 10-32 clip-nuts to full EIA hole centers (5/8 - 5/8 - 1/2 inch spacing)...
- Includes two pairs of rails (for rear support of heavier equipment), rubber feet, black ABS plastic handles, a starter pack of 10-32 clip nuts & matching 1421ABK black screws...
- Supplied unassembled (four cabinet pieces & four rails), shipped in a flat pack container for handling ease & protection (see photo below)...
- Simple assembly using one bolt in each corner to lock the sides to the top and bottom (hardware included)...
- Overall width 21"...
- Overall height 2" over panel space...
- Front & back lip is .585" so usable depth is reduced by 1.17"
- Recommended maximum weight (RCHV1902824 tested) - 800 pounds...
- Rugged textured powder paint finish...
- Stocked in Black & Light Gray (RAL7035)...

17.5" Deep models:











Part Number	Color	PDF Reader File	AutoCAD .dxf File (zipped)	Panel Height		Number of Clip Nuts & Screws Included	Wt. lbs.
				Inches	Units		
RCHV1900817BK1 RCHV1900817CG1 RCHV1900817LG1	Black Beige Light Gray	75K	79K	8.75	5	8	38
RCHV1901017BK1 RCHV1901017CG1 RCHV1901017LG1	Black Beige Light Gray	75K	80K	10.50	6	16	40
RCHV1901417BK1 RCHV1901417CG1 RCHV1901417LG1	Black Beige Light Gray	102K	109K	14.00	8	16	44
RCHV1901717BK1 RCHV1901717CG1 RCHV1901717LG1	Black Beige Light Gray	113K	124K	17.50	10	16	50
RCHV1902217BK1 RCHV1902217CG1 RCHV1902217LG1	Black Beige Light Gray	116K	128K	22.75	13	16	54
RCHV1902817BK1 RCHV1902817CG1 RCHV1902817LG1	Black Beige Light Gray	114K	129K	28.00	16	16	60

24.5" Deep models:



Part Number	Color	PDF Reader File	AutoCAD .dxf File	Panel Height		Number of Clip Nuts & Screws Included	Wt. lbs.
				Inches	Units		
RCHV1901024BK1 RCHV1901024CG1 RCHV1901024LG1	Black Beige Light Gray	91K	94K	10.50	6	16	52
RCHV1901424BK1 RCHV1901424CG1 RCHV1901424LG1	Black Beige Light Gray	121K	136K	14.00	8	16	58
RCHV1901724BK1 RCHV1901724CG1	Black Beige			17.50	10	16	62

RCHV1901724LG1	Light Gray	125K	141K				
RCHV1902224BK1	Black			22.75	13	16	70
RCHV1902224CG1	Beige						
RCHV1902224LG1	Light Gray	124K	149K				
RCHV1902824BK1	Black			28.00	16	16	78
RCHV1902824CG1	Beige						
RCHV1902824LG1	Light Gray	124K	152K				

31.5" Deep models:

Part Number	Color	 Reader File	AutoCAD .dxf File	Panel Height		Number of Clip Nuts & Screws Included	Wt. lbs.
				Inches	Units		
RCHV1901031BK1 RCHV1901031LG1	Black Light Gray	 97K	 108K	10.50	6	16	64
RCHV1901431BK1 RCHV1901431LG1	Black Light Gray	 133K	 164K	14.00	8	16	68
RCHV1901731BK1 RCHV1901731LG1	Black Light Gray	 145K	 176K	17.50	10	16	74
RCHV1902231BK1 RCHV1902231LG1	Black Light Gray	 149K	 184K	22.75	13	16	86
RCHV1902831BK1 RCHV1902831LG1	Black Light Gray	 152K	 191K	28.00	16	16	94

Feature Views:

Ships Flat For Handling Ease & Protection	Interior View With Infinitely Adjustable Panel Rails
	
Panel Rails (Two Pair Included) With 10-32 Black Clip Nuts & Mounting Hardware	
	

Accessories:



Casters - Part Number 1425PHD

- **SOLD IN A SET OF 4**
- Base of cabinet is punched to accept this caster set
- 600# Mfg's specified weight capacity (Set of 4)
- Features ball bearing swivel and hard composition wheels
- Small foot print 2.125" x 15/16" hole mounting pattern
- Wheels are grey & 2" wheel diameter
- Includes mounting hardware



Doors

- 16-gauge steel construction
- Both front & back of "RCHV" rack cabinets are punched to accept these doors
- Mounts either right or left hand hinge (door & cabinet are symmetrical)
- Includes installed lock and two keys
- Finished in rugged textured powder paint to match RCHS/RCHV enclosures
- Includes mounting hardware



Part Number	Color	PDF Reader File	AutoCAD .dxf File	Use With Cabinet Panel Height	Wt. lbs.
RCHD1908BK1 RCHD1908CG1 RCHD1908LG1	Black Beige Light Gray	17K	179K	8" (5 U)	5
RCHD1910BK1 RCHD1910CG1 RCHD1910LG1	Black Beige Light Gray	18K	192K	10.5" (6 U)	5
RCHD1914BK1 RCHD1914CG1 RCHD1914LG1	Black Beige Light Gray	19K	219K	14" (8 U)	6
RCHD1917BK1 RCHD1917CG1 RCHD1917LG1	Black Beige Light Gray	21K	246K	17.5" (10 U)	7
RCHD1922BK1 RCHD1922CG1 RCHD1922LG1	Black Beige Light Gray	22K	285K	22.75" (13 U)	9
RCHD1928BK1 RCHD1928CG1 RCHD1928LG1	Black Beige Light Gray	24K	329K	28" (16 U)	12



Extra Panel Rails

- RCHV rack cabinets ship with two pair - order below for extra mounting capabilities
- **Sold in pairs**
- Finished in rugged black textured powder paint
- Includes amhal strut mounting hardware (black clip nuts are not included)

Part Number	Use With Cabinet Panel Height
RCHR1908	8" (5 U)
RCHR1910	10.5" (6 U)
RCHR1914	14" (8 U)
RCHR1917	17.5" (10 U)
RCHR1922	22.75" (13 U)
RCHR1928	28" (16 U)



Extra Spring Nuts - Part Number 1421SN

- 1/4 - 20 Strut nut
 - 1/4 - 20 x 1/2 bolt
- Used only in our RCHS & RCHV table top rack cabinets - handy for mounting of other

- equipment to the horizontal struts
- **Sold in packages of 8 (8 spring nuts and 8 bolts) as shown**



Replacement Rubber Feet - Part Number 1421RC24

- RCHV rack cabinets ship with four feet included - order these for replacement
- **Sold in package of 20**



PART No. RCHV1902217

for more information visit
www.hammfg.com

Data subject to change without notice.
Isometric drawing not to scale.
Shipped knockdown for handling ease
& protection.

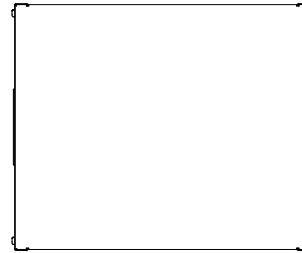
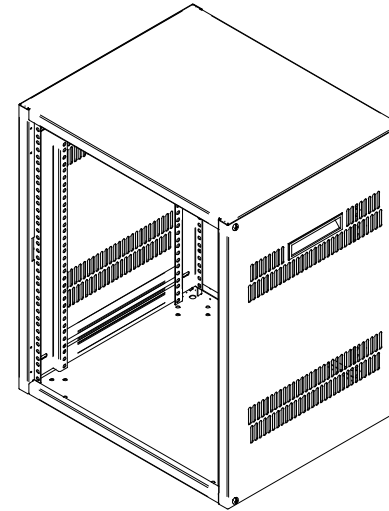

TOP VIEW

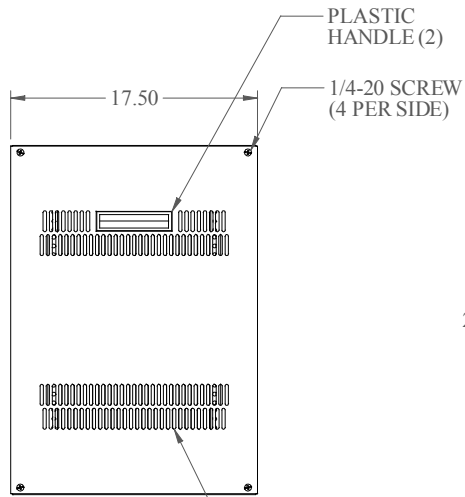

L.S. VIEW

VENTILATION
SLOTS

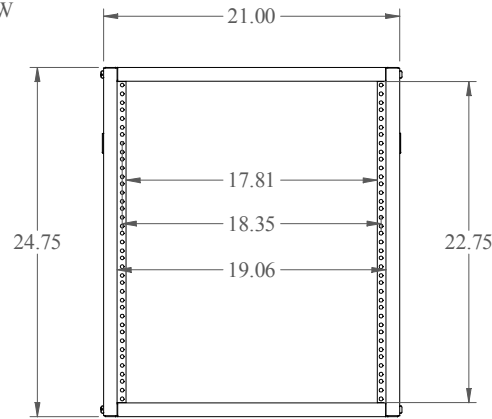

FRONT VIEW

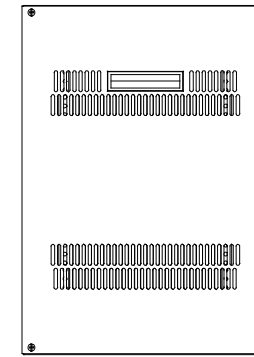

R.S. VIEW

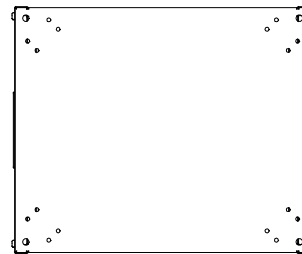

BOTTOM VIEW